

ACR

STOVES

AWARD WINNING
ELECTRIC STOVE AND INSERT RANGE



British Designed
Stoves



C O N T E N T S

03 | Introduction

04 | Essential stove information

ELECTRIC INSERT RANGE

06 | PR-600e insert : 1.6 kw

08 | PR-900e insert : 1.6 kw

10 | PR-1200e insert : 2 kw

12 | PR-1200e fire-surround options

13 | Insert optional fireplace range

ELECTRIC STOVE RANGE

16 | MALVERN^e : 2 kw

18 | ASTWOOD^e : 2 kw

20 | TRINITY^e : 2 kw

22 | NEO3F^e : 2 kw

24 | NEO3C^e : 2 kw

26 | Accessories range





ELECTRIC STOVE AND INSERT RANGE



With thirty years experience designing some of the world's finest woodburning and multifuel stoves, we are pleased to offer the award winning range of ACR premium quality electric stoves and inserts.

As our lives become ever more hectic and our homes more efficient, it may not always be practical to install a real traditional woodburning stove.

Our innovative electric stoves now offer you similar ambience and enjoyment.

Designed and engineered from the ground up to meet the needs of modern room heating, we have used our extensive expertise with stove manufacturing to create a range of truly ingenious electric stoves and inserts.

We construct our electric stoves and inserts from premium grade lightweight steel, beautifully finished in a black powder-coat finish, for an authentic look and feel. This also makes the stoves and inserts incredibly durable, as such they all come with a two year warranty as standard.

Our electric stoves and inserts are equipped with some of the most

advanced technology available featuring LED 3D holographic projection. This creates an incredibly realistic appearance of flickering flames in the front, centre and rear of the fuel bed. With four whisper quiet settings - high flame, medium flame, low flame and smouldering embers, there will always be a setting to suit your mood.

All stoves and inserts have two heat settings (please see individual product pages for specifications) to provide instant heat with thermostatic control and the convenience of a seven day timer, all adjustable from the fully programmable remote control. Or in the case of the fireplace inserts by using the ACR App on your smart device. There is also an option for the flame effect only with no heat. Our insert range also features sixteen lighting options as standard to suit your mood and room ambience.

For thoroughly modern homes and living, our range of electric stoves and inserts really do offer the best of traditional and contemporary, with all the convenience you could hope for.

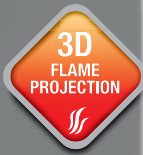

All of our electric stoves and inserts feature LED 3D holographic flame projection for an ultra-realistic fire effect.

'Flame Projection Technology'* creates flames in front, centre and rear of the fuel bed.

There is also an additional switchable option of a blue flame to add further ambience to our electric stoves range, and 16 selectable flame colourways for our inserts range.

The effect can be adjusted from a soothing glow through to a welcoming log fire.

*Patent applied for.



To see our electric stoves in action, please scan the QR code.



To see our electric inserts in action, please scan the QR code.





The PR-600e, PR-900e and PR-1200e all feature 64 different effect options - including coloured flame effects, high flame, medium flame, low flame and smouldering embers only. All adjustable from the supplied intelligent remote control or the downloadable ACR App.

Essential insert and stove information



INSERT AND STOVE CONSTRUCTION

Our range of electric stoves and inserts are manufactured from lightweight, but durable steel and finished in a traditional black powder-coat, to keep them looking their best for many years. As electric stoves do not reach the very high internal temperatures of a woodburning stove there is no need for cast iron or heavyweight steel components. This means our stoves are lighter in weight, but still retain the look and feel of a real stove and offer much greater durability than similar products.

THE ELECTRIC FIRE EXPERIENCE

Featuring incredibly realistic LED 3D holographic flame projection, with an additional blue flame option and four settings - high flame, medium flame, low flame and a smouldering embers effect, our stoves really do have that real fire ambience. LED lighting ensures longevity and lower running costs. Realistic ceramic logs resting on a bed of crystals give the appearance of glowing embers and further adds to the atmosphere. Each stove and insert has two selectable heat settings (please see each model for actual heat outputs) - and also a no-heat setting so you can still enjoy the flame effect on warmer evenings or for when no additional room heating is required.

Our insert range also features sixteen options for lighting and flame colour, all selectable from the multifunction remote control supplied as standard or by using the downloadable ACR App.

All of our electric stoves and inserts feature a thermal cut-out safety device to protect the appliance from over-heating.



PUTTING YOU IN CONTROL OF YOUR INSERT AND STOVE

All of our stoves and inserts are supplied with a convenient 2-in-1 intelligent remote control. All the day-to-day functions, such as turning the stove on and off and adjusting the flame effect settings, are directly accessible with an LED screen to show your chosen settings. Slide open the lower section of the handset to reveal the programmable seven day timer facility with a three settings per day timer and fully adjustable thermostatic control. All our stoves also feature onboard controls for turning the stove on and off and for adjusting the heat and flame effect settings too.



Our insert range can also be controlled with the ACR App when installed on your smart device, giving you even greater flexibility to tailor your fire to suit your needs and mood.



2 YEAR WARRANTY

Designed and engineered to the highest standards we pride ourselves on offering a premium quality electric stove experience, this is fully backed up by our extensive two year warranty for your peace of mind. Full warranty details & exclusions can be found on our website <https://acrheatproducts.com/warranties>

INSTALLATION INFORMATION

Our electric stove and insert range offers incredible realism and heat from just the flick of a switch. In most instances, you can simply plug in and you're up and running, but please note that clearances to combustibles must be observed and a hearth may be required. Please consult your ACR dealer for further information if you are unsure.

STOVE ACCESSORIES RANGE

A range of specially designed accessories are also available to enhance your electric stove installation. With gloss black hearth plates for wall and corner settings and matching flue pipe kit suitable for all of our electric stoves, there is also a gloss black top plate and storage base plinth available exclusively for the NEO range and a log store base option for the Malvern. Please see page 26 for further details.

INSERT FIRE-SURROUNDS

Our insert range of electric fires have their own specially designed range of fire-surrounds, available in easy to assemble and install kit form. All components are ready finished and require no further painting to complete. Please see each insert product page and page 13 for details on specific fire-surrounds for each insert model.



ACR electric stoves and inserts are not only suitable for bringing style and warmth to a conventional setting, but are also ideal for heating a wide range of homes and building types.

Optional flue kit is available from the ACR Electric Stoves accessories range to complete the look of your installation. Please see page 26 for more details.



PR-600e **0.8Kw / 1.6Kw**

Electric fireplace insert with a fire-surround option featuring a reversible panel.

The PR-600e is the most compact of our inserts, featuring 16 different flame effects and 2 heat settings. The PR-600e can be installed into our bespoke, hand-crafted in the heart of the Midlands, Harborne Fireplace suite as featured, or installed into your own preferred setting.

- High quality but lightweight steel construction with a traditional black powder-coat finish
- 0.8Kw and 1.6Kw heat settings
- Incredibly realistic LED 3D holographic flame projection with 64 different effect options - including coloured flame effects, high flame, medium flame, low flame and smouldering embers only
- The LED flame effect can be used without heat so you can enjoy a flickering fire all year round with minimal energy usage
- 'Flame Projection Technology'* creates flames in front, centre and rear of the fuel bed
- Ultra-realistic ceramic logs with crystal embers for a natural embers glow
- Whisper quiet flame effect
- 7 day programmable 2 in1 intelligent remote control for convenient adjustment of all insert settings and features
- ACR app available for smart devices to give enhanced control of your fires settings
- Safety thermal cut-out in the event of over-heating
- Flat wall fit - easy to install with no need for major alterations to your wall**
- 2 year warranty

*Patent applied for. **When used in conjunction with the ACR bespoke fireplace.



SPECIFICATIONS

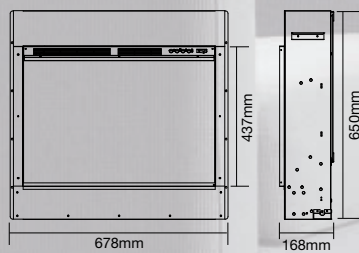

Construction	High quality steel
Fuel	Domestic electricity supply
Selectable Heat Output	0 kw / 0.8Kw / 1.6 Kw
Power Consumption - default flame effect	17.2 W
Thermostatic control	Digital programmable
Remote control	2 in1 intelligent remote control 7 day programmable
App control	Available from your App Store
Safety features	Thermal cutout
Weight	19.2 kg



The featured Harborne Fireplace Suite comes with everything you need to complete this look and has a reversible black back panel to bespoke your design*. See page 13 for full specifications.

*ornaments not included



Up to 64 standard colour lighting and effect options.

Flat wall fit.
No chopping out or major wall alterations to install insert**

Complete the look.
Bespoke fireplace shown is available to order
See page 13



To see the PR-600e insert in action, please scan the QR code.



PR-900e 0.8Kw / 1.6Kw

Electric fireplace insert with a range of fire-surround options.

The PR-900e can be installed into not only an existing fireplace or our purposely designed Edgbaston fireplace suite as shown, but is also ideally proportioned to be included in a versatile media wall in even the cosiest of rooms.

- High quality but lightweight steel construction with a traditional black powder-coat finish
- 0.8Kw and 1.6Kw heat settings
- Incredibly realistic LED 3D holographic flame projection with 64 different effect options - including coloured flame effects, high flame, medium flame, low flame and smouldering embers only
- The LED flame effect can be used without heat so you can enjoy a flickering fire all year round with minimal energy usage
- 'Flame Projection Technology'* creates flames in front, centre and rear of the fuel bed
- Ultra-realistic ceramic logs with crystal embers for a natural embers glow
- Whisper quiet flame effect
- 7 day programmable 2 in1 intelligent remote control for convenient adjustment of all insert settings and features
- ACR app available for smart devices to give enhanced control of your fires settings
- Safety thermal cut-out in the event of over-heating
- Flat wall fit - easy to install with no need for major alterations to your wall
- 2 year warranty

*Patent applied for. **When used in conjunction with the ACR bespoke fireplace.



SPECIFICATIONS

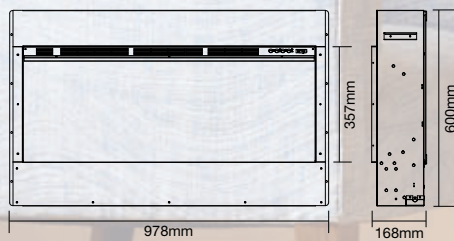

Construction	High quality steel
Fuel	Domestic electricity supply
Selectable Heat Output	0 kw / 0.8 Kw / 1.6 Kw
Power Consumption - default flame effect	24 W
Thermostatic control	Digital programmable
Remote control	2 in1 intelligent remote control 7 day programmable
App control	Available from your App Store
Safety features	Thermal cutout
Weight	24.3 kg



The Edgbaston fireplace suite is available to purchase separately and has been hand-crafted in the heart of the Midlands. Choose from either the wall hanging or the floor standing versions to personalise your living space. Please see page 13 for full specifications.



Up to 64 standard colour lighting and effect options.

Flat wall fit.
No chopping out or major wall alterations to install insert**

Complete the look.
Bespoke fireplace shown is available to order
See page 13



To see the PR-900e insert in action, please scan the QR code.



PR-1200e **1Kw / 2Kw**

Panoramic electric fireplace insert with a range of fire-surround options.

Our PR-1200e insert is a truly versatile addition for your home. It can be installed in up to 4 different styles: Single front as a true 'hole in the wall' feature. Fully open to give an unparalleled view of the flame effect. Or for a truly bespoke option, the left or right end glass panel can be utilised to create your own unique fireplace.

- High quality but lightweight steel construction with a traditional black powder-coat finish
- 1Kw and 2Kw heat settings
- Incredibly realistic LED 3D holographic flame projection with 64 different effect options - including coloured flame effects, high flame, medium flame, low flame and smouldering embers only
- The LED flame effect can be used without heat so you can enjoy a flickering fire all year round with minimal energy usage
- 'Flame Projection Technology'* creates flames in front, centre and rear of the fuel bed
- Ultra-realistic ceramic logs with crystal embers for a natural embers glow
- Whisper quiet flame effect
- 7 day programmable 2 in1 intelligent remote control for convenient adjustment of all insert settings and features
- ACR app available for smart devices to give enhanced control of your fires settings
- Safety thermal cut-out in the event of over-heating
- Flat wall fit - easy to install with no need for major alterations to your wall
- 2 year warranty

*Patent applied for. **When used in conjunction with the ACR bespoke fireplace.



SPECIFICATIONS

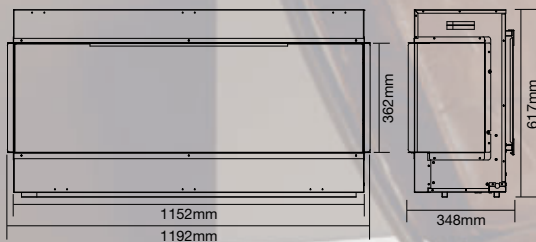

Construction	High quality steel
Fuel	Domestic electricity supply
Selectable Heat Output	0 kw / 1 Kw / 2 Kw
Power Consumption - default flame effect	24.1 W
Thermostatic control	Digital programmable
Remote control	2 in1 intelligent remote control 7 day programmable
App control	Available from your App Store
Safety features	Thermal cutout
Weight	46.3 kg



Handmade in the heart of the Midlands, the Brindley fireplace brings a sense of style to your home. Available as a wall hanging or floor standing fireplace and with optional end panels to give complete flexibility to your design. Please see pages 12 and 13 for full specifications.



Up to 64 standard colour lighting and effect options.

Flat wall fit.
No chopping out or major wall alterations to install insert**

Complete the look.
Bespoke fireplace shown is available to order
See page 13



To see the PR-1200e insert in action, please scan the QR code.

The Brindley Fireplace Suite range, designed exclusively for the PR-1200e electric insert.

There are three options within the wall-hanging and floor-standing Brindley Suite fireplaces for the PR-1200e. The PR-1200e is supplied as standard with four glass panel configurations, so you can tailor your fireplace to create your perfect installation as shown below. All fire-surrounds are supplied in an easy to assemble and install kit form and are ready painted.



Wall-hanging 'hole in the wall' surround.



Floor-standing 'hole in the wall' surround.



Wall-hanging surround with right aspect visible (also available as a left aspect).



Floor-standing surround with right aspect visible (also available as left aspect).



Wall-hanging fully open surround for unparalleled views of the flame effect.



Floor-standing fully open surround for unparalleled views of the flame effect.



Mist
surround
finish option

Fireplace Suite specifications for the PR-600e, PR-900e and PR-1200e inserts.

All our fire-surrounds are hand-crafted in the Midlands and are supplied in an easy to assemble and install kit form. They are ready painted with two colour options available: Parchment and Mist.

Harborne Fireplace Suite for the PR-600e fireplace insert

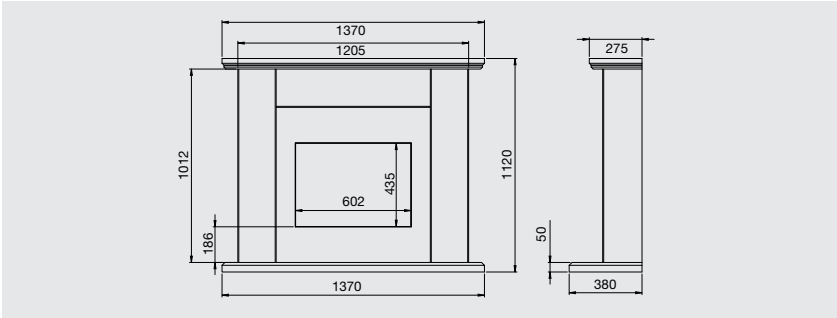

Edgbaston Fireplace Suite for the PR-900e fireplace insert

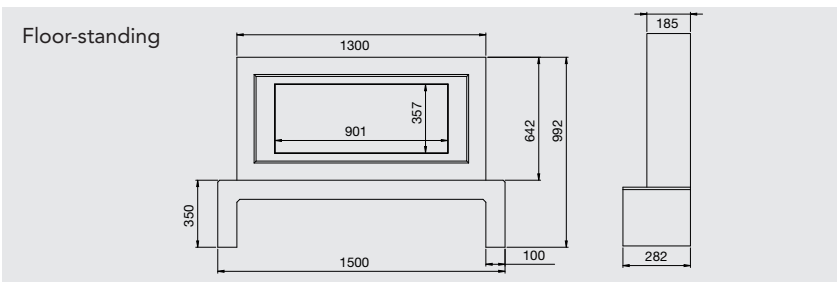
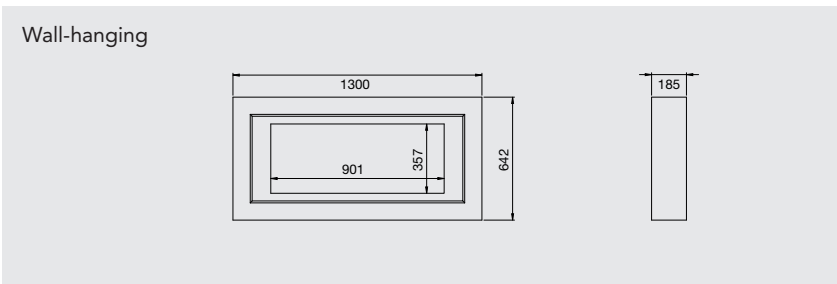

Brindley Fireplace Suite for the PR-1200e fireplace insert

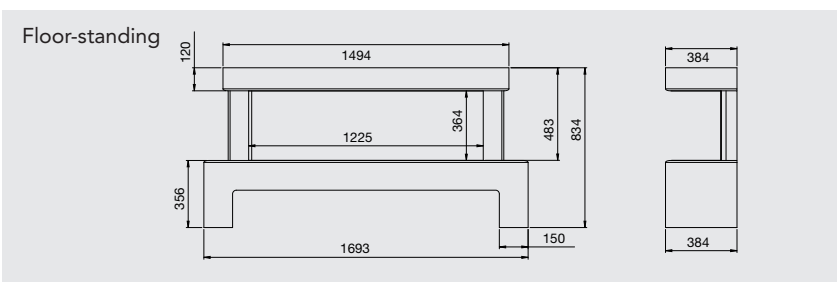
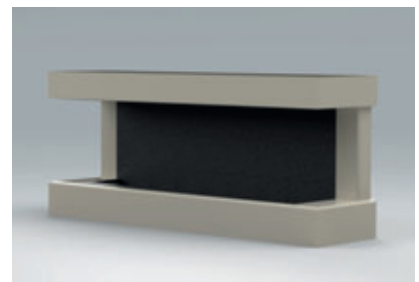
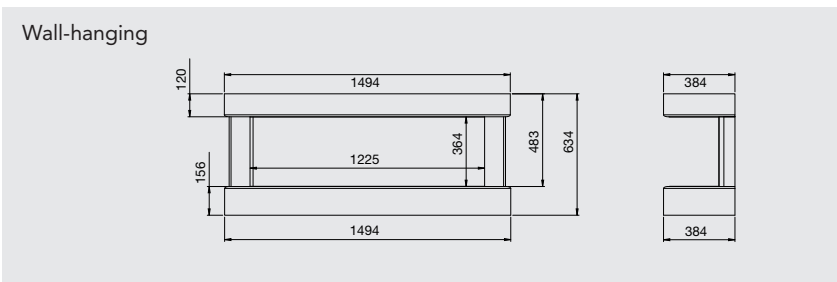

With boundless possibilities when it comes to creating the perfect fireplace to fit into your families' lifestyle, let your imagination guide you to the reality.

A media wall as shown here, featuring the PR-1200e, can be created to beautifully store all the day-to-day gadgets the average family home now has, whilst providing a focal point in the heart of your home.



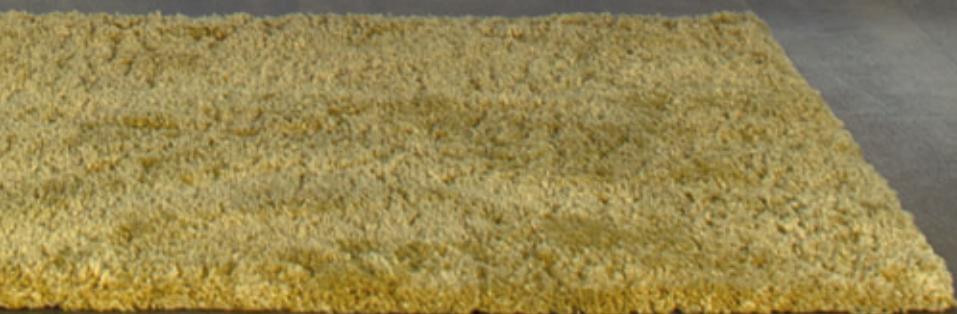

To see the PR-1200e
insert in action, please
scan the QR code.



To see our electric stoves in action, please scan the QR code.

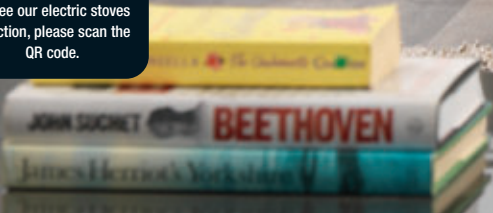

ELECTRIC

MALVERN^e 1kw / 2kw

The MALVERN^e features contemporary styling and is suitable for a wide range of home and conservatory settings, being the most compact stove in the range. A log-store base is also available as an option to create an authentically convincing stove setting.

- High quality but lightweight steel construction with a traditional black powder-coat finish
- 1 Kw, 2 Kw and no-heat settings
- Incredibly realistic LED 3D holographic flame projection with four settings: high flame, medium flame, low flame and smouldering embers only
- The LED flame effect can be used without heat so you can enjoy a flickering fire all year round with minimal energy usage
- 'Flame Projection Technology'* creates flames in front, centre and rear of the fuel bed
- Blue flame option for greater ambience
- Ultra-realistic ceramic logs with crystal embers for a natural embers glow
- Whisper quiet flame effect
- 7 day programmable 2 in1 intelligent remote control for convenient adjustment of all stove settings and features
- Safety thermal cut-out in the event of over-heating
- 2 year warranty

*Patent applied for.



SPECIFICATIONS

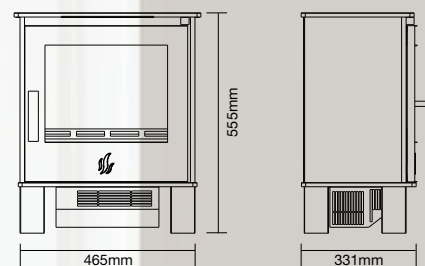

Overall height with the optional log-store is 775mm

Construction	High quality steel
Fuel	Domestic electricity supply
Selectable Heat Output	0 kw / 1 Kw / 2 Kw
Power Consumption - Flame Effect	10 -12 W
Thermostatic control	Digital programmable
Remote control	2 in1 intelligent remote control 7 day programmable
Safety features	Thermal cutout
Weight	21 kg

A log-store base option is available for the Malvern electric stove to create an authentic woodstove ambience.



To see our electric stoves
in action, please scan the
QR code.

ELECTRIC

ASTWOOD^e 1kw / 2kw

The ASTWOOD^e has all the charm and cosy warmth of a traditionally styled stove, and is a perfect complement to slightly larger settings and rooms.

- High quality but lightweight steel construction with a traditional black powder-coat finish
- 1Kw, 2Kw and no-heat settings
- Incredibly realistic LED 3D holographic flame projection with four settings: high flame, medium flame, low flame and smouldering embers only
- The LED flame effect can be used without heat so you can enjoy a flickering fire all year round with minimal energy usage
- 'Flame Projection Technology'* creates flames in front, centre and rear of the fuel bed
- Blue flame option for greater ambiance
- Ultra-realistic ceramic logs with crystal embers for a natural embers glow
- Whisper quiet flame effect
- 7 day programmable 2 in1 intelligent remote control for convenient adjustment of all stove settings and features
- Safety thermal cut-out in the event of over-heating
- 2 year warranty

*Patent applied for.



SPECIFICATIONS

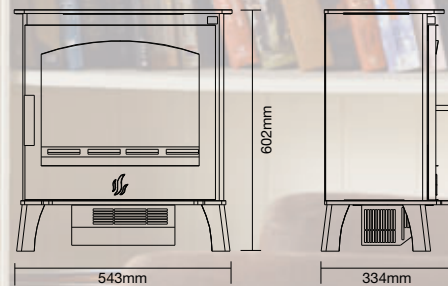

Construction	High quality steel
Fuel	Domestic electricity supply
Selectable Heat Output	0 kw / 1 Kw / 2 Kw
Power Consumption - Flame Effect	10 -12 W
Thermostatic control	Digital programmable
Remote control	2 in1 intelligent remote control 7 day programmable
Safety features	Thermal cutout
Weight	24 kg



TRINITY^e 1kw / 2kw

The TRINITY^e is an award winning stove with clean contemporary lines, featuring additional side window panels. The heating system is incorporated within the stove body for a clean and uncluttered look.

- High quality but lightweight steel construction with a traditional black powder-coat finish
- 1 Kw, 2 Kw and no-heat settings
- Incredibly realistic LED 3D holographic flame projection with four settings: high flame, medium flame, low flame and smouldering embers only
- The LED flame effect can be used without heat so you can enjoy a flickering fire all year round with minimal energy usage
- 'Flame Projection Technology'* creates flames in front, centre and rear of the fuel bed
- Blue flame option for greater ambiance
- Ultra-realistic ceramic logs with crystal embers for a natural embers glow
- Whisper quiet flame effect
- 7 day programmable 2 in1 intelligent remote control for convenient adjustment of all stove settings and features
- Safety thermal cut-out in the event of over-heating
- 2 year warranty

*Patent applied for.



SPECIFICATIONS

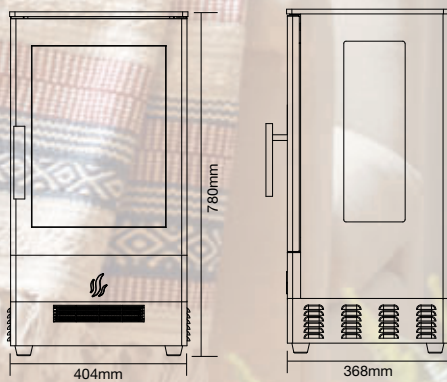

Construction	High quality steel
Fuel	Domestic electricity supply
Selectable Heat Output	0 kw / 1 Kw / 2 Kw
Power Consumption - Flame Effect	10 -12 W
Thermostatic control	Digital programmable
Remote control	2 in1 intelligent remote control 7 day programmable
Safety features	Thermal cutout
Weight	33 kg

Optional flue kit is available from the ACR Electric Stoves accessories range to complete the look of your installation.
Please see page 26 for more details.



To see our electric stoves in action, please scan the QR code.



Optional flue kit is available from the ACR Electric Stoves accessories range to complete the look of your installation. Please see page 26 for more details.



To see our electric stoves in action, please scan the QR code.



ELECTRIC

NEO3F^e 1kw / 2kw

The NEO3F^e is an award winning contemporary styled stove with the distinctive feature of two side window panels, creating a focal point and sense of occasion for any setting.

- High quality but lightweight steel construction with a traditional black powder-coat finish
- 1Kw, 2Kw and no-heat settings
- Incredibly realistic LED 3D holographic flame projection with four settings: high flame, medium flame, low flame and smouldering embers only
- The LED flame effect can be used without heat so you can enjoy a flickering fire all year round with minimal energy usage
- 'Flame Projection Technology'* creates flames in front, centre and rear of the fuel bed
- Blue flame option for greater ambiance
- Ultra-realistic ceramic logs with crystal embers for a natural embers glow
- Whisper quiet flame effect
- 7 day programmable 2 in1 intelligent remote control for convenient adjustment of all stove settings and features
- Safety thermal cut-out in the event of over-heating
- 2 year warranty

*Patent applied for.



SPECIFICATIONS

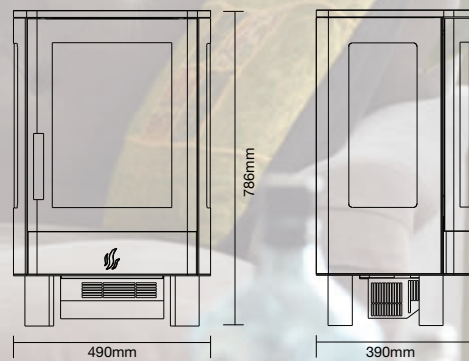

Construction	High quality steel
Fuel	Domestic electricity supply
Selectable Heat Output	0 kw / 1 Kw / 2 Kw
Power Consumption - Flame Effect	10 -12 W
Thermostatic control	Digital programmable
Remote control	2 in1 intelligent remote control 7 day programmable
Safety features	Thermal cutout
Weight	35 kg

Optional flue kit is available from the ACR Electric Stoves accessories range to complete the look of your installation. Please see page 26 for more details.



To see our electric stoves in action, please scan the QR code.



NEO3C^e 1kw / 2kw

The NEO3C^e features a log store in the base, allowing you to create a truly authentic looking installation. Along with its two additional side window panels this is a stove to really make a statement in any room.

- High quality but lightweight steel construction with a traditional black powder-coat finish
- 1Kw, 2Kw and no-heat settings
- Incredibly realistic LED 3D holographic flame projection with four settings: high flame, medium flame, low flame and smouldering embers only
- The LED flame effect can be used without heat so you can enjoy a flickering fire all year round with minimal energy usage
- 'Flame Projection Technology'* creates flames in front, centre and rear of the fuel bed
- Blue flame option for greater ambiance
- Ultra-realistic ceramic logs with crystal embers for a natural embers glow
- Whisper quiet flame effect
- 7 day programmable 2 in1 intelligent remote control for convenient adjustment of all stove settings and features
- Safety thermal cut-out in the event of over-heating
- 2 year warranty

*Patent applied for.



SPECIFICATIONS

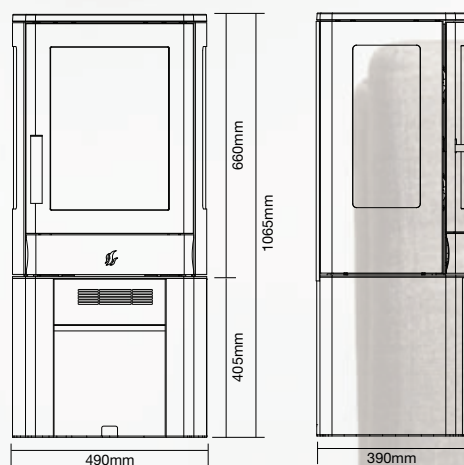

Construction	High quality steel
Fuel	Domestic electricity supply
Selectable Heat Output	0 kw / 1 Kw / 2 Kw
Power Consumption - Flame Effect	10 -12 W
Thermostatic control	Digital programmable
Remote control	2 in1 intelligent remote control 7 day programmable
Safety features	Thermal cutout
Weight	45 kg

Electric stoves accessories range

Our accessory has been designed exclusively to complement our electric stove range and enhance your installation. Please note these accessories are not suitable for use with either woodburning or multifuel stove applications.

BLACK GLASS HEARTHES

Our 6mm thick glass hearth plates are the ideal way to display your electric stove. With a deep gloss black finish, there are options for either a corner setting, or a versatile rectangular format that can be sited against a wall or used free-standing. Our glass hearths are suitable for use with all stoves in our electric range.

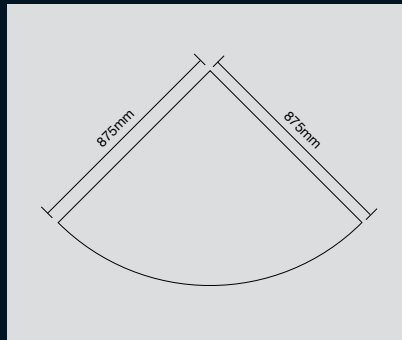
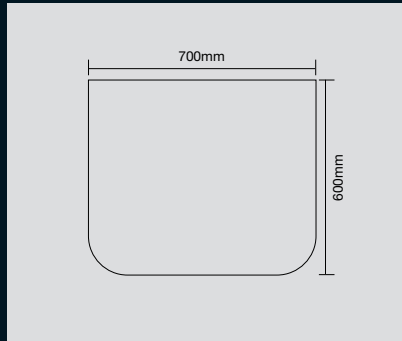

NEO BLACK GLASS TOP PLATE

With a deep gloss black finish, our 6mm thick glass top plate adds a distinctive finish to the NEO electric stoves.



ELECTRIC STOVE FLUE PIPE

Specially designed flue pipe kit to further enhance your stoves installation and to create a convincing setting. Straightforward magnetic installation, suitable for all ACR electric stoves.



MALVERN LOG STORE BASE

Add a log-store base section to the standard Malvern electric stove for an authentic woodburning stove look.

Glass hearth plate shown is also available from the ACR electric stoves accessories range.



NEO3F STORAGE CONVERSION

An attractive storage base that can be added to the NEO3F to create a NEO3C pedestal style stove.



To see our electric stoves
in action, please scan the
QR code.



To see our electric stoves in action, please scan the QR code.



To see our electric inserts in action, please scan the QR code.



E-Malvern 2Kw electric stove, please see page 16 for more information.

Your local ACR dealer:



Scan code with your mobile device for more information



ACR Heat Products Limited, Unit 1, Weston Works, Weston Lane, Tyseley Birmingham B11 3RP, England.

• Tel: 0121 706 8266

• E-mail: enquiries@acrheatproducts.co.uk

• www.acrstoves.com

Issue 1 / February 2022

All installations shown in this brochure are for illustrative purposes only. All actual installations must comply with the latest building regulations and ACR Heat Products Ltd installation manuals. Please note that due to limitations of the printing process, colour reproduction of the inserts, stoves, fireplaces and surrounds may vary slightly from those shown. Please consult your dealer for more accurate colour matching. ACR Heat Products Ltd reserves the right to amend any specifications herein or to make any product design changes. The specifications, dimensions and information shown within our brochures are provided for information purposes only and are not binding. With the aim of constantly improving our equipment, all modifications considered necessary may be made without notice.